

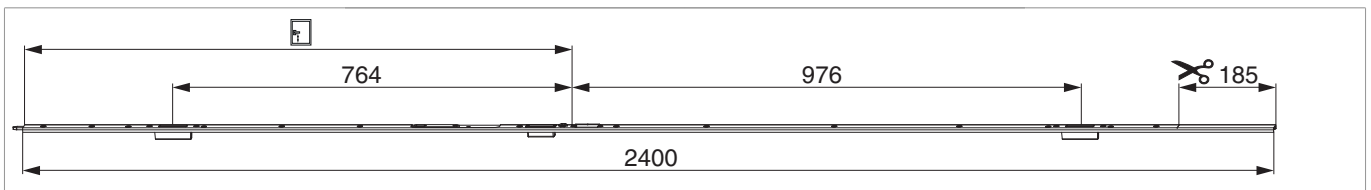









## 219593 - Stulpflügelgetriebe 2MF-HO K+980 GM1.050 rechts Silber U-8/28/8

### Technische Zeichnung



							<b>L</b>			<b>N<sup>o</sup></b>
Silber	rechts	2MF-HO K+980	1.050	8	28	8	2.400	185	5	219593

### Schraubpositionstabelle

<b>N<sup>o</sup></b>		1	2	3	4	5	6	7	8	9	10	11	12	13	14	15	16	17	18	19	20
219593	14	-1.013	-920	-849	-704	-555	-405	-99	87	260	505	745	916	1.036	1.123						

### Positionierung des Stulpflügelgetriebes

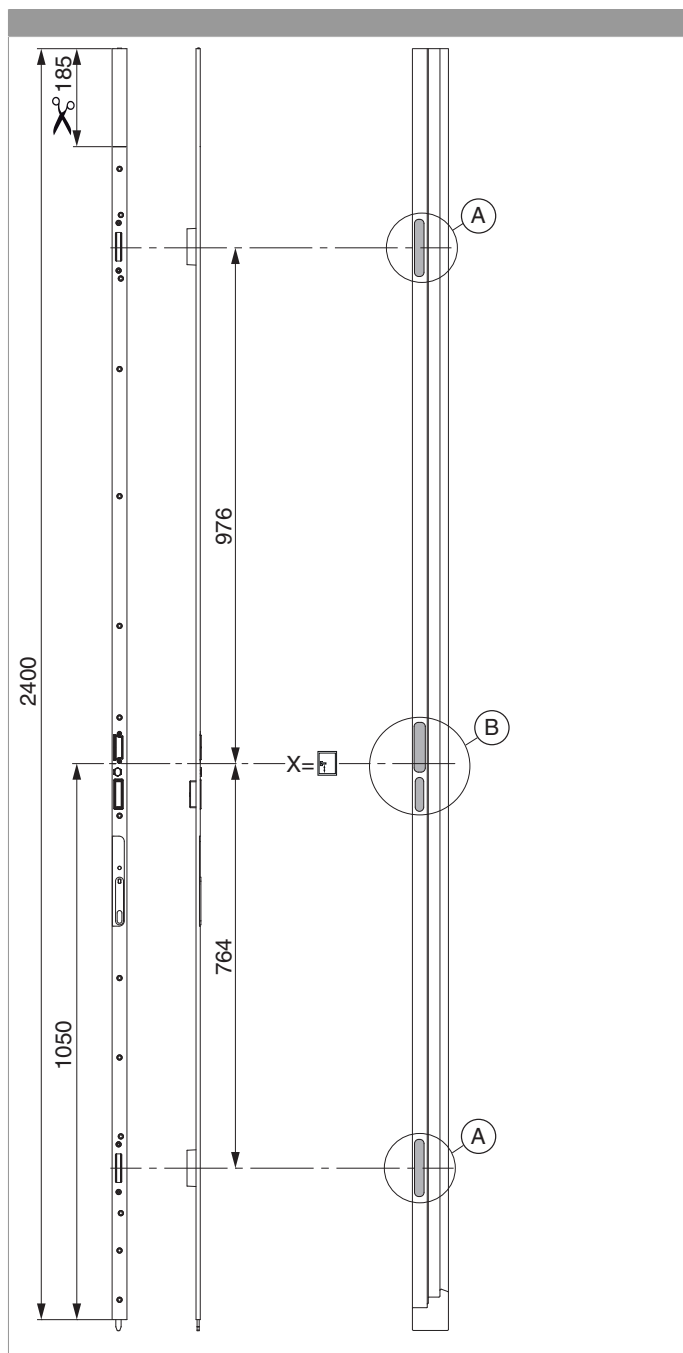

### Bohr- und Fräsbild

Detail A

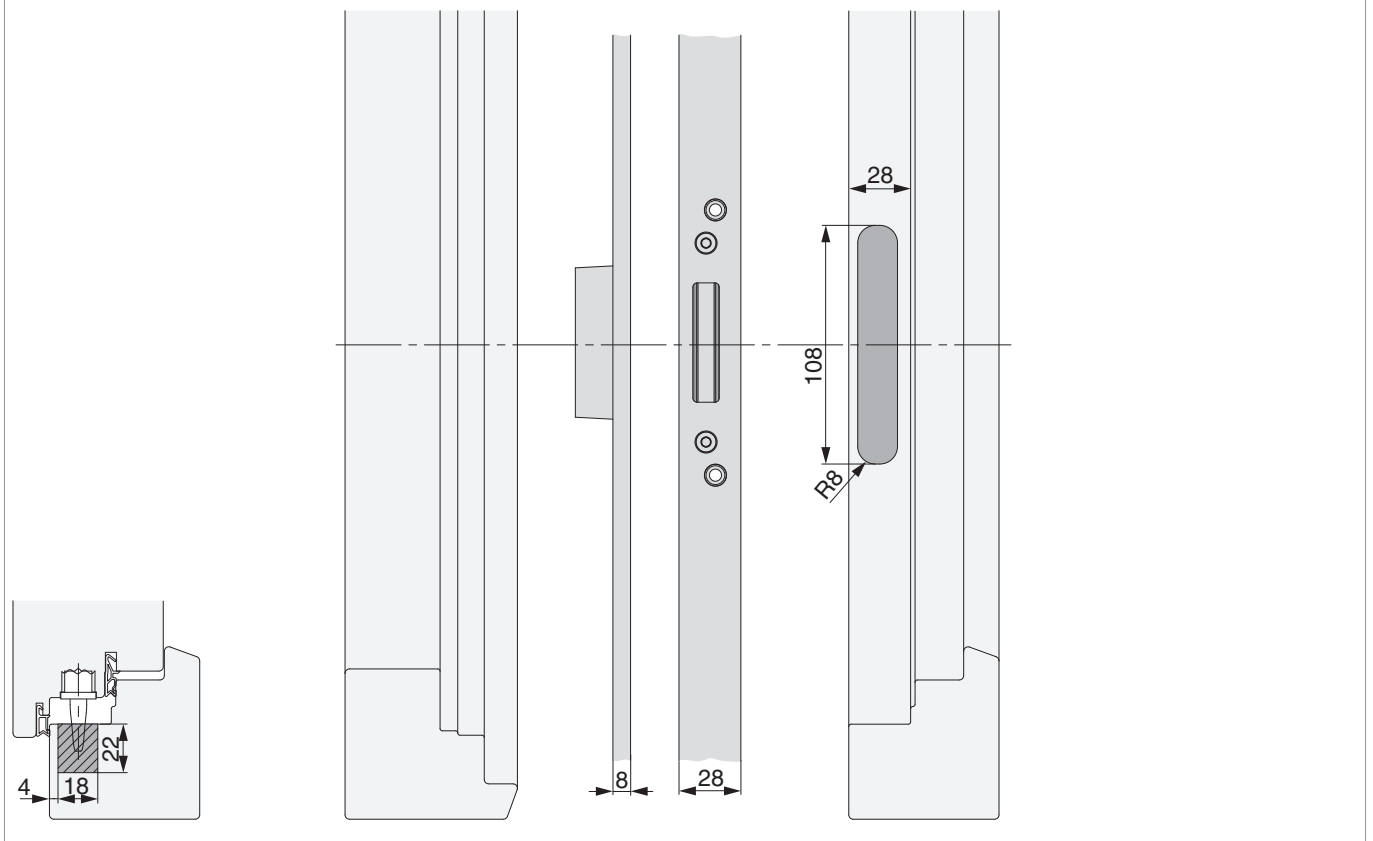

Detail B

