

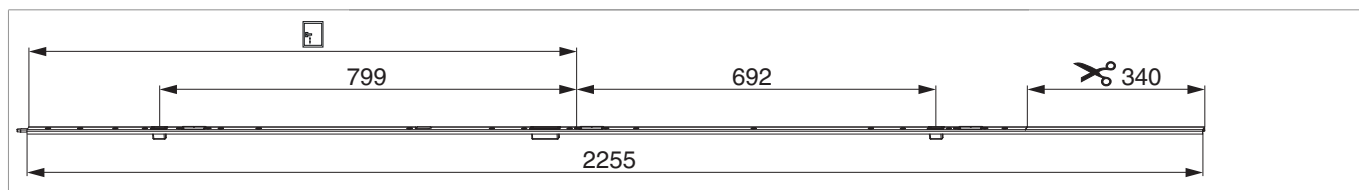









219424 - Stulpflügelgetriebe 2MF-BO GM1.050 links Silber U-8/24/8

Technische Zeichnung



							L			N^o
Silber	links	2MF-BO	1.050	8	24	8	2.255	340	5	219424

Schraubpositionstabelle

N^o		1	2	3	4	5	6	7	8	9	10	11	12	13	14	15	16	17
219424	16	-1.012	-950	-883	-826	-680	-608	-318	-160	-98	-11	117	342	567	629	717	824	

Positionierung des Stulpflügelgetriebes

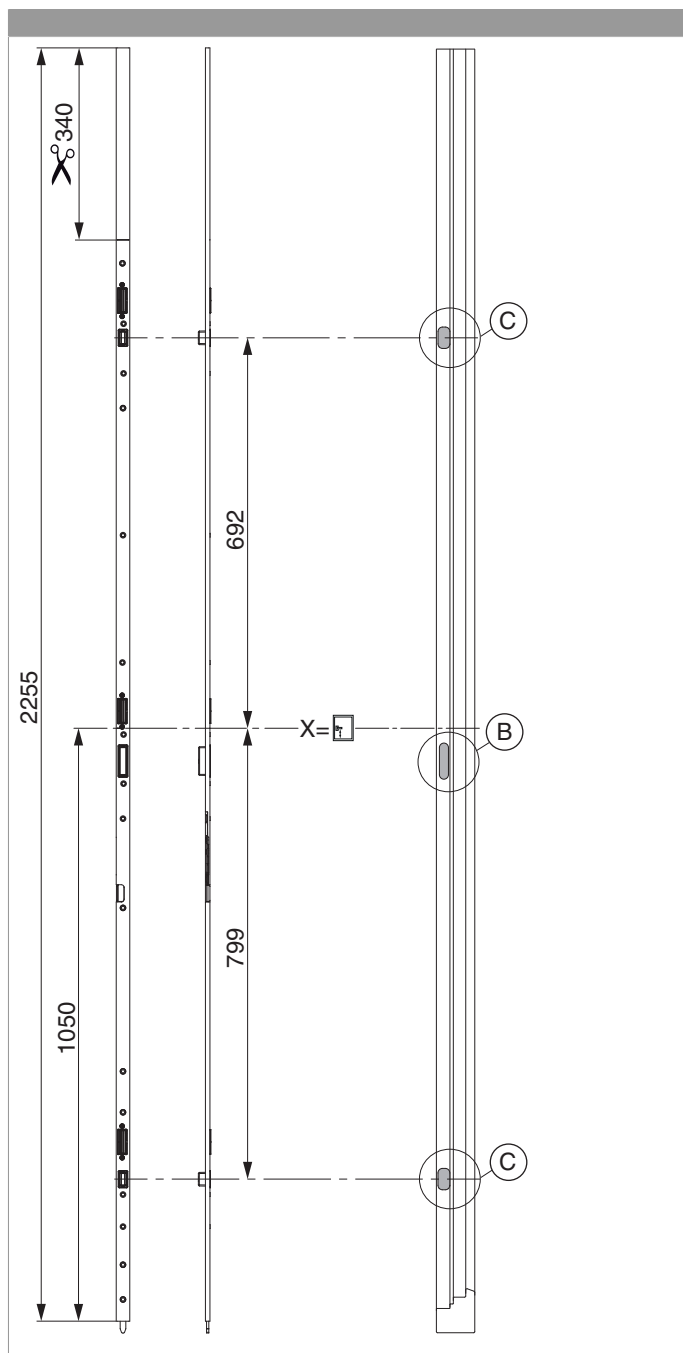

Bohr- und Fräsbild

Detail B

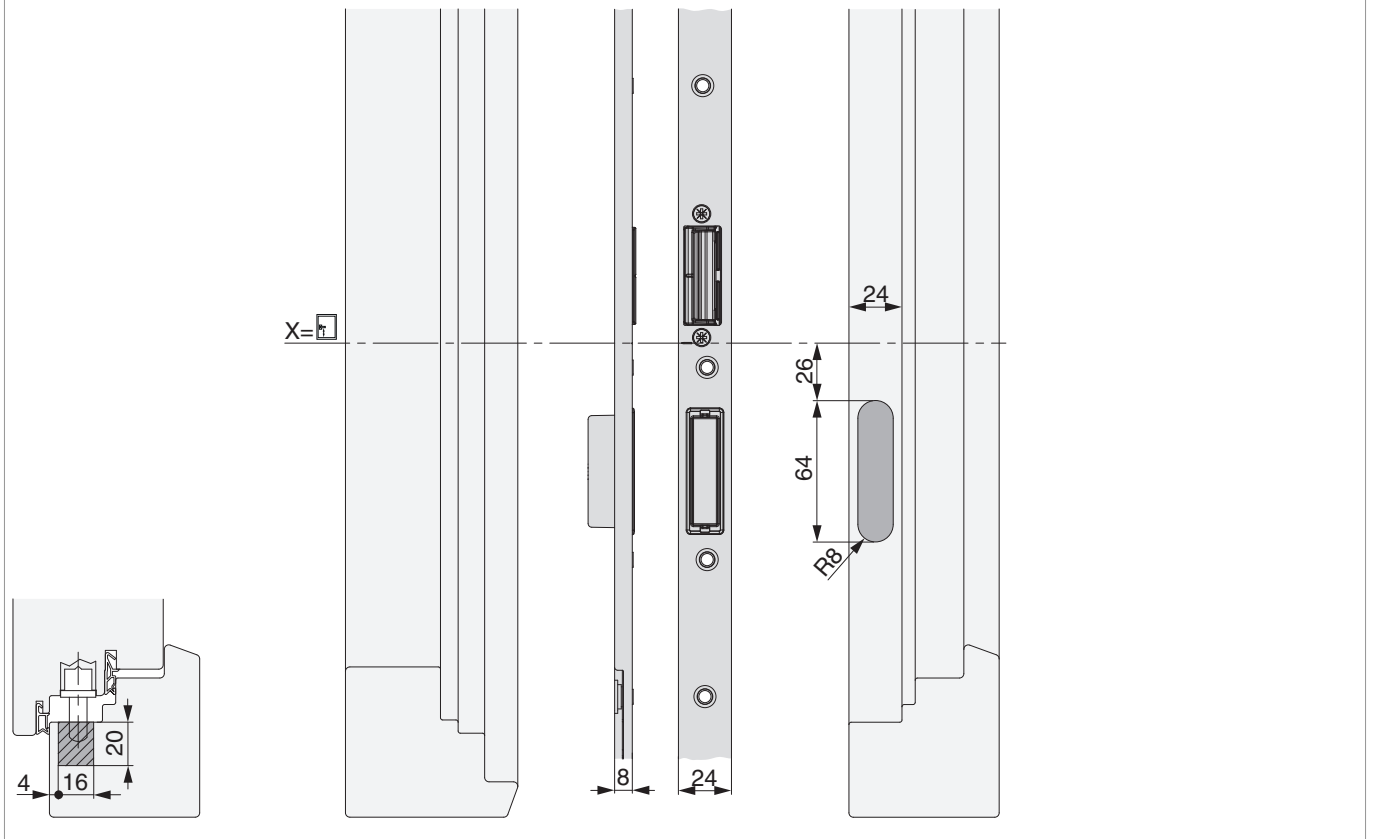

Detail C

